

# Finishing Options

## Standard Perforation | SP

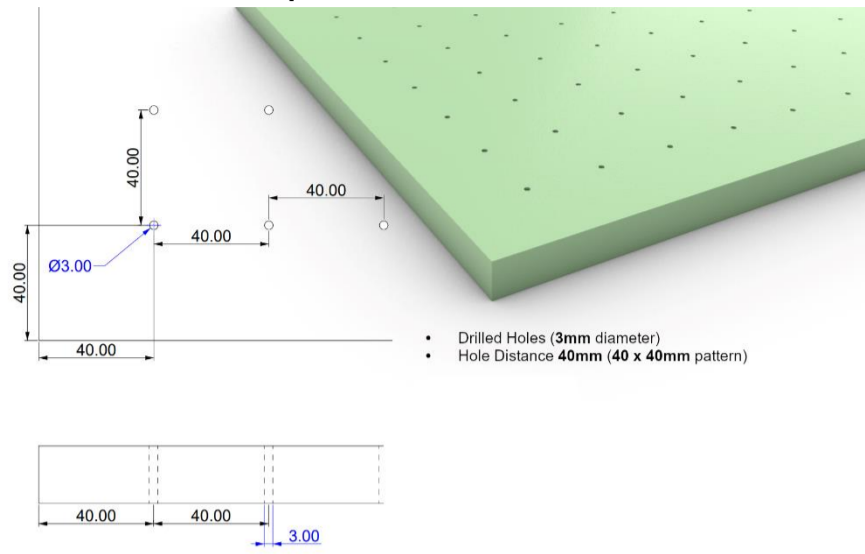

## Double Perforation | DP

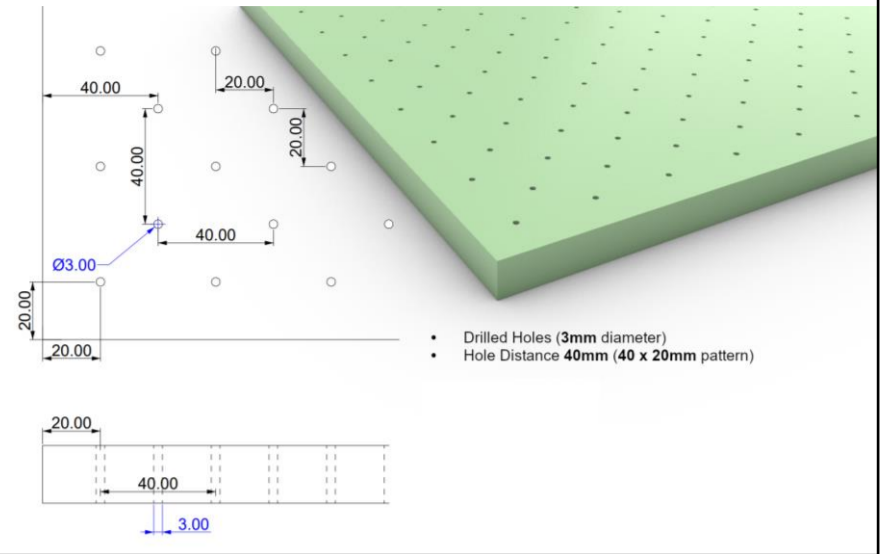

## Standard Groove Standard Perforation – 1 Side | SGSP1

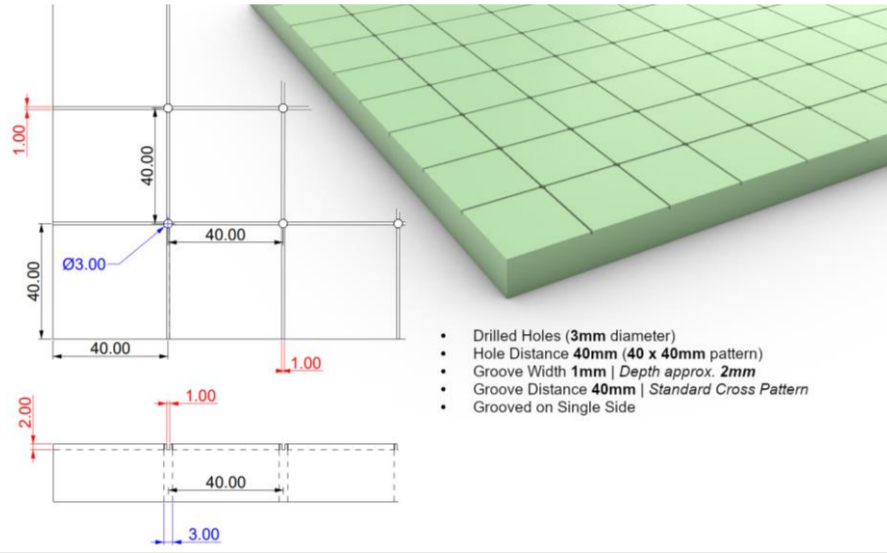

## Standard Groove Double Perforation – 1 Side | SGDP1

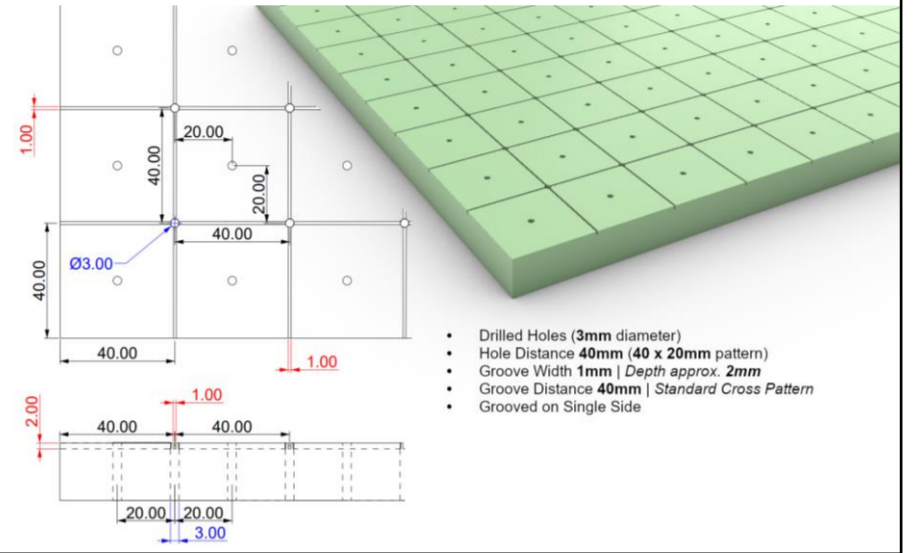

## Standard Groove Standard Perforation – 2 Side | SGSP2

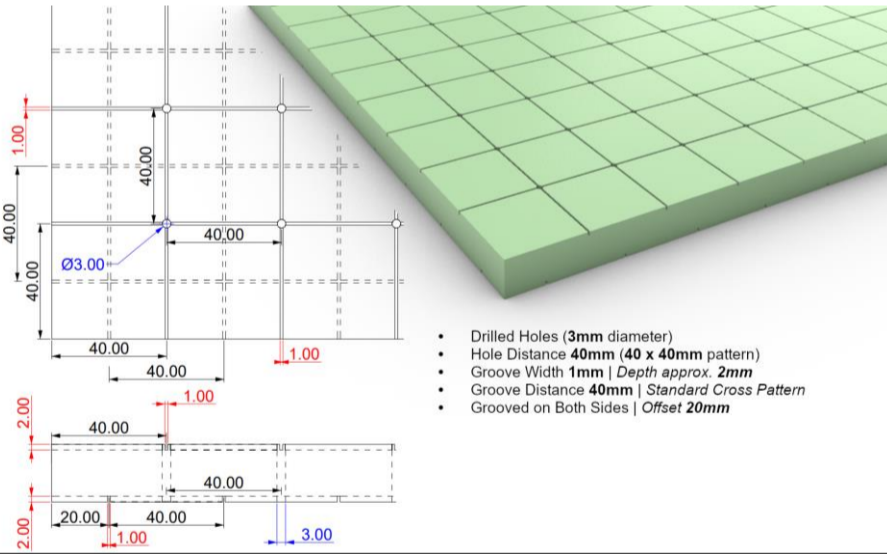

## Standard Groove Double Perforation – 2 Side | SGDP2

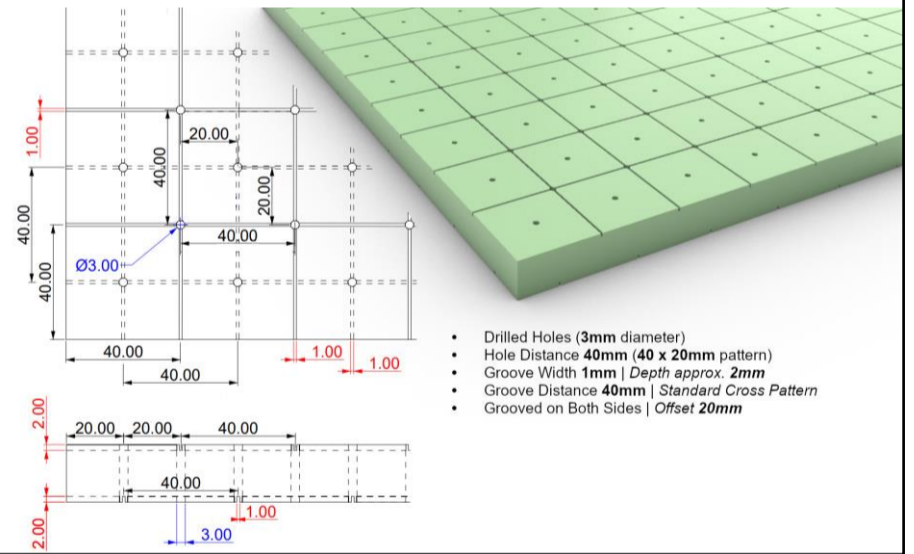

## Double Groove Standard Perforation – 1 Side | DGSP1

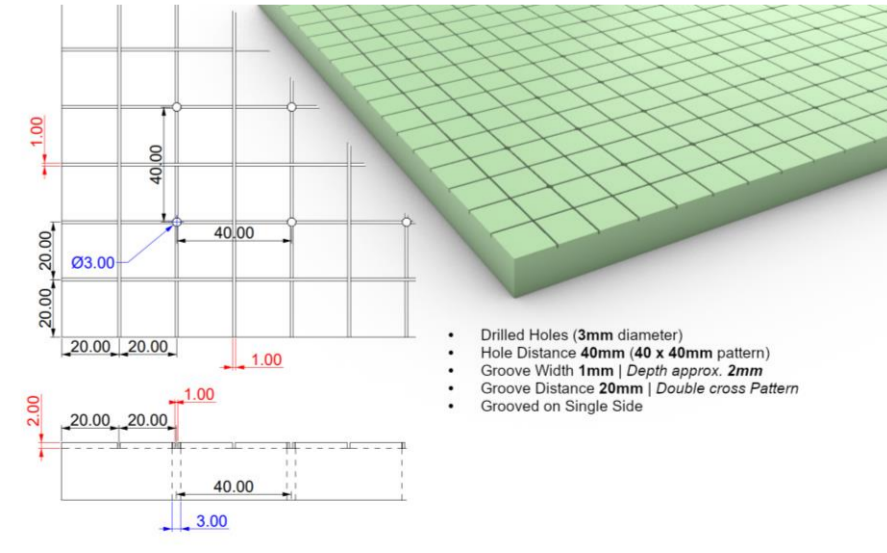

## Double Groove Double Perforation – 1 Side | DGDP1

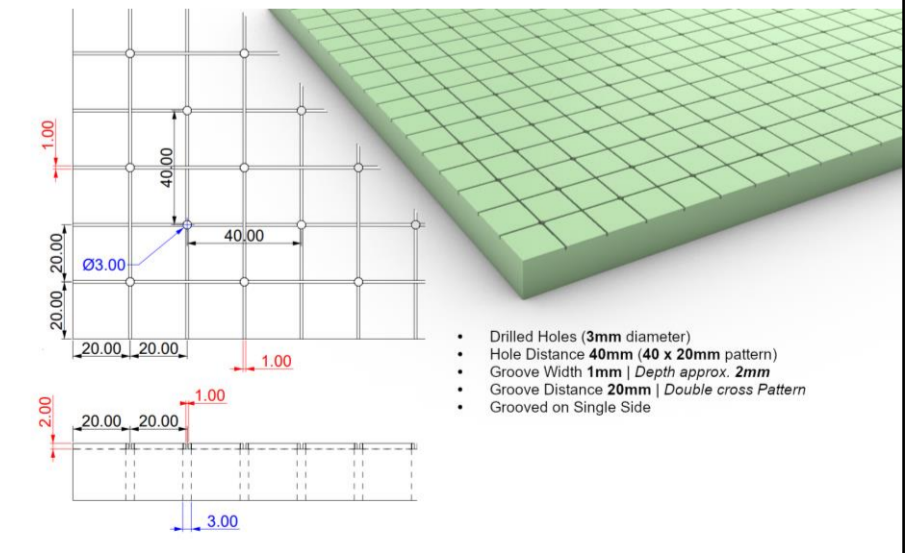

# Finishing Options

## Double Groove Standard Perforation – 2 Sides | DGSP2

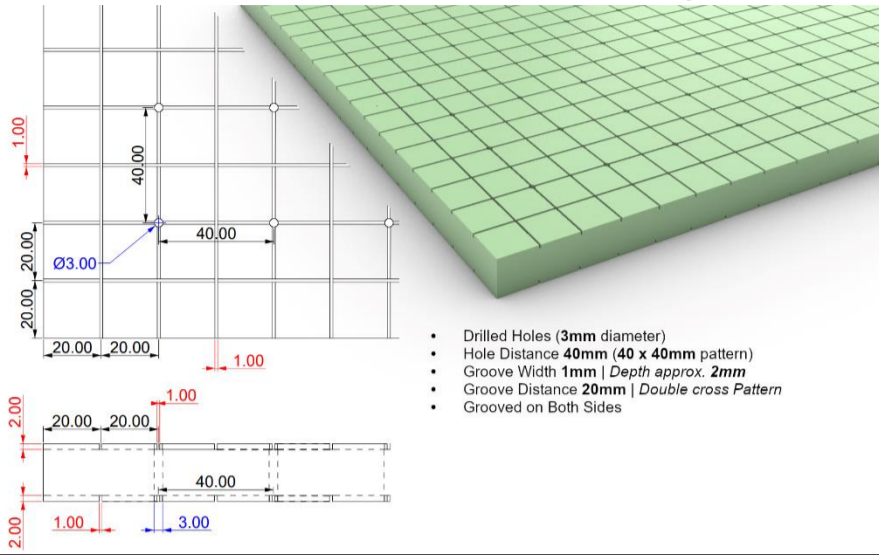

- Drilled Holes (3mm diameter)
- Hole Distance 40mm (40 x 40mm pattern)
- Groove Width 1mm | Depth approx. 2mm
- Groove Distance 20mm | Double cross Pattern
- Grooved on Both Sides

## Double Groove Double Perforation – 2 Sides | DGDP2

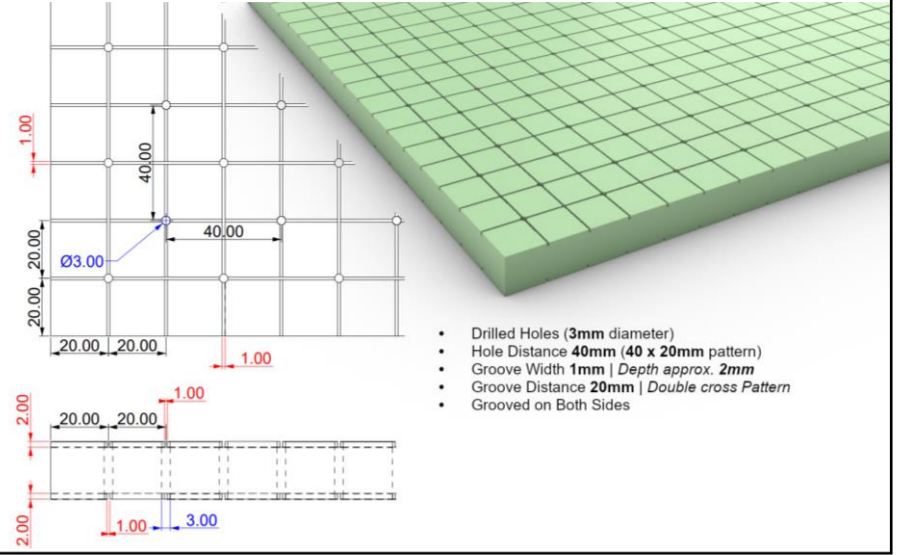

- Drilled Holes (3mm diameter)
- Hole Distance 40mm (40 x 20mm pattern)
- Groove Width 1mm | Depth approx. 2mm
- Groove Distance 20mm | Double cross Pattern
- Grooved on Both Sides

## Standard Parallel Lines Standard Perforation – 1 Side | SPLSP1

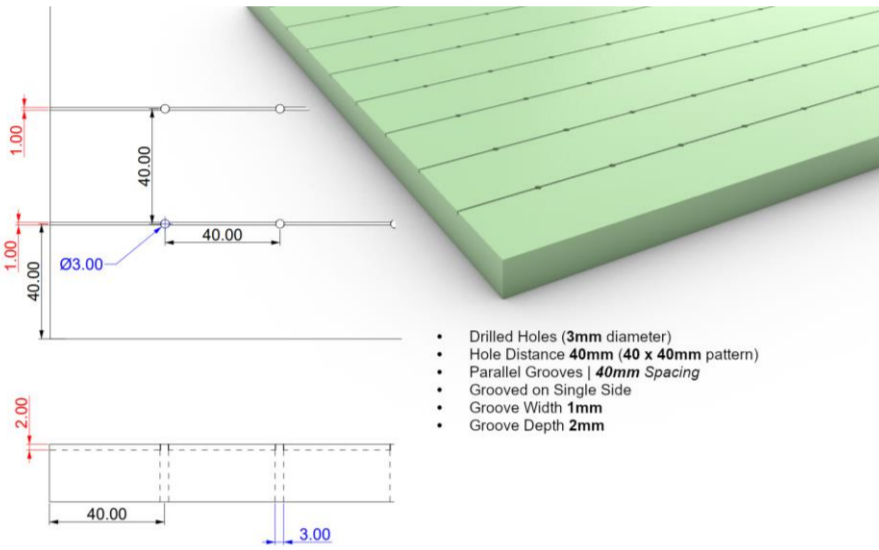

- Drilled Holes (3mm diameter)
- Hole Distance 40mm (40 x 40mm pattern)
- Parallel Grooves | 40mm Spacing
- Grooved on Single Side
- Groove Width 1mm
- Groove Depth 2mm

## Standard Parallel Lines Double Perforation – 1 Side | SPLDP1

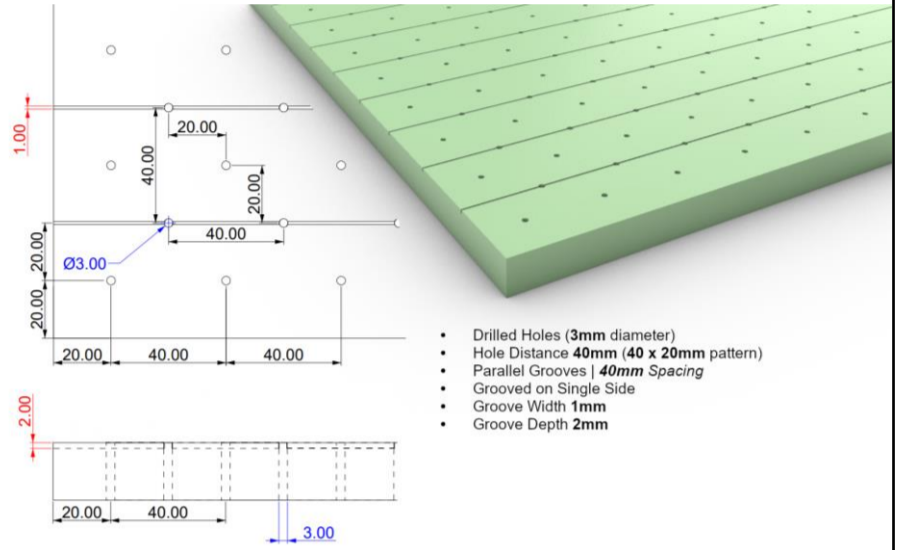

- Drilled Holes (3mm diameter)
- Hole Distance 40mm (40 x 20mm pattern)
- Parallel Grooves | 40mm Spacing
- Grooved on Single Side
- Groove Width 1mm
- Groove Depth 2mm

## Standard Parallel Lines Standard Perforation – 2 Side | SPLSP2

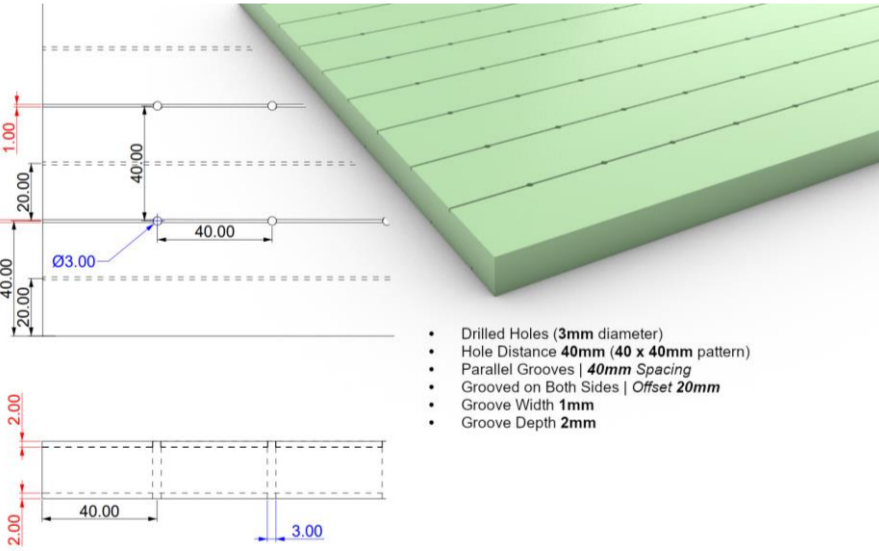

- Drilled Holes (3mm diameter)
- Hole Distance 40mm (40 x 40mm pattern)
- Parallel Grooves | 40mm Spacing
- Grooved on Both Sides | Offset 20mm
- Groove Width 1mm
- Groove Depth 2mm

## Standard Parallel Lines Double Perforation – 2 Side | SPLDP2

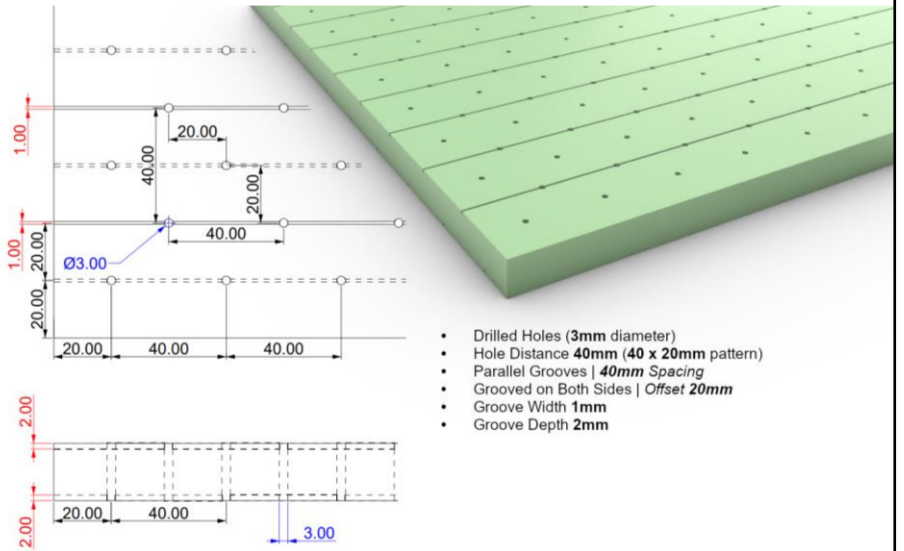

- Drilled Holes (3mm diameter)
- Hole Distance 40mm (40 x 20mm pattern)
- Parallel Grooves | 40mm Spacing
- Grooved on Both Sides | Offset 20mm
- Groove Width 1mm
- Groove Depth 2mm

## Scoreboard | SB

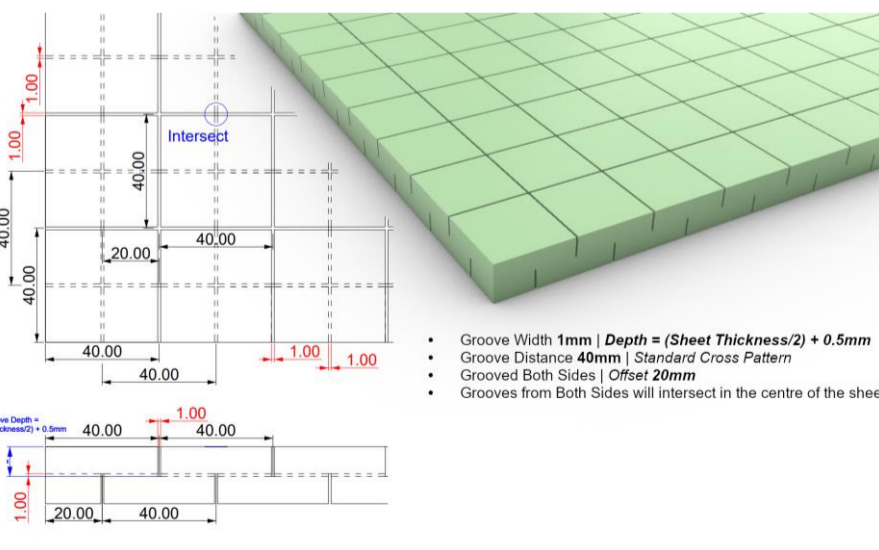

- Groove Width 1mm | Depth = (Sheet Thickness/2) + 0.5mm
- Groove Distance 40mm | Standard Cross Pattern
- Grooved Both Sides | Offset 20mm
- Grooves from Both Sides will intersect in the centre of the sheet

## SCR40 | Scrimback

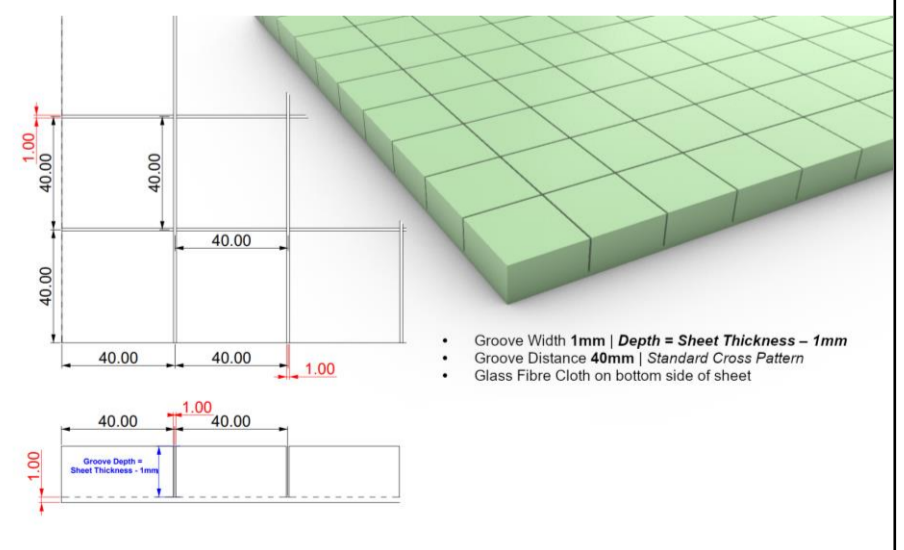

- Groove Width 1mm | Depth = Sheet Thickness - 1mm
- Groove Distance 40mm | Standard Cross Pattern
- Glass Fibre Cloth on bottom side of sheet

# Finishing Options

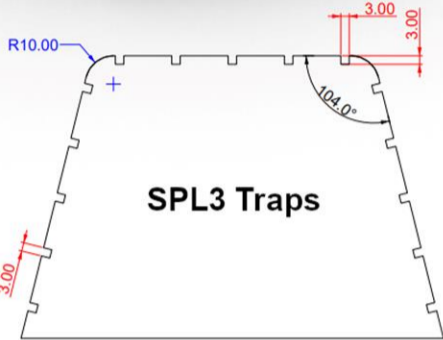
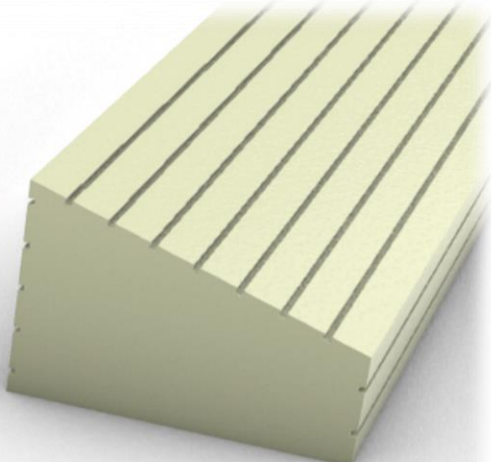
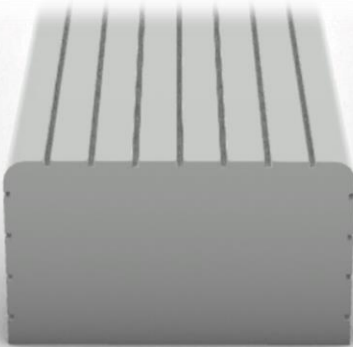
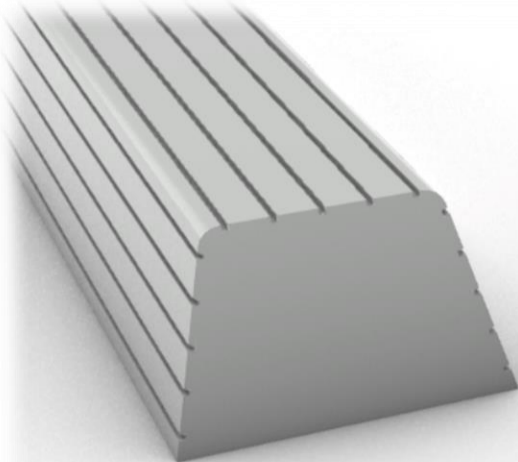

- Trapezoidal Profile | **1220mm** Lengths
- Parallel Grooves 3 Sides | **20mm** Spacing
- Groove Width **3mm**
- Groove Depth **3mm**
- Radiused corners on request

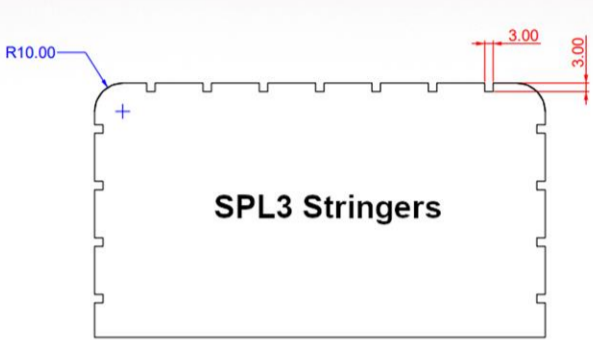

- Rectangular Profile | **1220mm** Lengths
- Parallel Grooves 3 Sides | **20mm** Spacing
- Groove Width **3mm**
- Groove Depth **3mm**
- Radiused corners on request

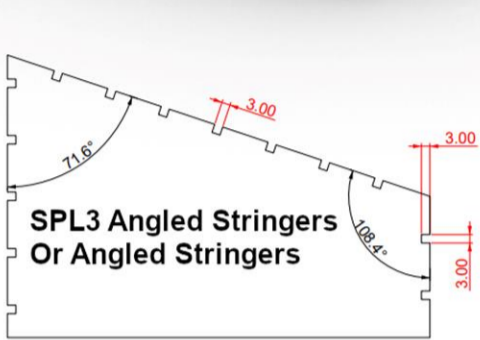

- Angled Profile | **1220mm** Lengths
- Tricast 2 – Plain
- Tricast 3 – Parallel Grooves 3 sides | **20mm** Spacing
- Groove Width **3mm**
- Groove Depth **3mm**